



A large format banner 'A' frame made from lightweight aluminium, ideal for use with PVC eyelet banners. Available in two sizes Monsoon is very easy to use, reusable and is the perfect graphics carrier for venues, events, exhibitions, promotions and indoor or outdoor shows.

features & benefits

- Indoor or outdoor banner system
- Suitable for single or double sided display
- 3 frame sizes 1250mm x 1250mm, 1000mm x 2500mm and 1250mm x 3000mm
- Natural finish 25mm (1") square aluminium tubes with reinforced plastic mouldings
- Easy push-fit assembly, no tools necessary
- Graphics are secured to the frame with elastic bungee cords
- Supplied complete carry bag
- Flat packs for easy transportation
- Recommended for use in wind conditions upto Beaufort Scale 5

hardware specifications

Assembled Dimensions (mm)

1250 x 1250 frame

1200 (h) x 1200 (w) x 795 (d) approx

1000 x 2500 frame

975 (h) x 2500 (w) x 640 (d) approx

1250 x 3000 frame

1200 (h) x 3000 (w) x 795 (d) approx

Weight (including carry bag):

1250 x 1250 frame 4.1kg approx

1000 x 2500 frame 6kg approx.

1250 x 3000 frame 8.1kg approx.

graphic specifications

Visible Graphic Area:

1040 (h) x 1040 (w) mm

840 (h) x 2340 (w) mm

1090(h) x 2840 (w) mm

additional info

Recommended Accessories:

1250mm x 150mm diameter cardboard/tube carry bag for transporting graphics

Assembly Instructions

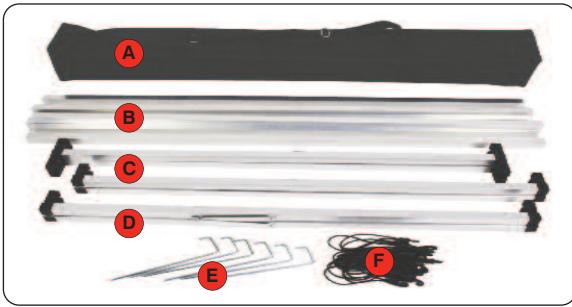

Kit Includes:

Carry bag (A) Horizontal tube x8 (B)
Centre 'A' frame x1 (C) End 'A' frame x 2 (D)
Ground peg x6 (E) and Elastic bungee cord x24 (F)

Frame assembly



Open up all the End and Centre 'A' frames

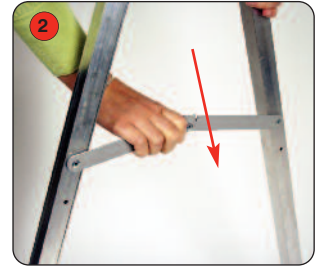

Push each locking arm down to secure the frame

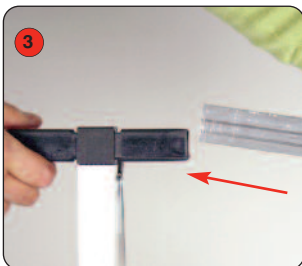

Push fit the top horizontal tubes into the 'A' frames, ensure the plastic joiners face inwards

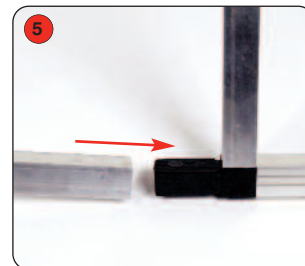
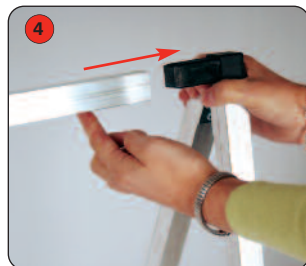

Push fit the bottom horizontal tubes into the 'A' frames, ensure the plastic joiners face inwards

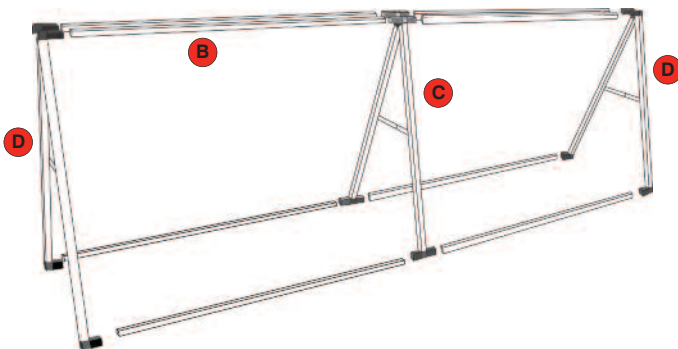

Graphic attachment

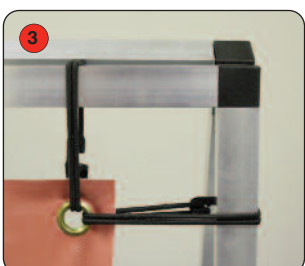

Pass the elastic bungee cord through the graphic eyelet and around the frame to secure

Corner eyelets require a bungee cord loop around the top and the side of the frame to secure

Ground peg fixing

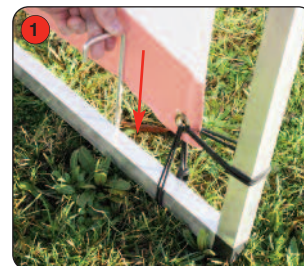

To secure the frame to grassed areas, push or hammer the ground peg into the ground



Ensure the ground peg covers the horizontal tube